



PUMA

ACOWA
INSTRUMENTS

User manual

ACOWA Puma / AcowaZoo

062022



ACOWA
INSTRUMENTS

Table of Contents

Content

PUMA.....	4
About PUMA	4
Functions:	4
PUMA and advanced flow calculation:.....	5
Safety instructions	7
Installation.....	9
Power supply.....	9
Physical measurements	9
Environment	9
Built-in power supply	9
Analog input.....	9
Digital inputs	10
Digital outputs.....	10
Pump.....	10
Operation	11
Overview	11
Installation guide.....	12
Display	13
Display 2,4" OLED and operation	13
AcowaZoo.....	15
Connecting to a PC.....	15
USB connection.....	15
TCP Connection.....	15
AcowaZoo Installation.....	15
Driver installation.....	15
Program installation.....	15
Configuration.....	17

AcowaZoo user interface	17
Overview	17
Function buttons.....	17
Function menu.....	18
Settings selection	21
PUMA details	21
Pump setup.....	22
Settings for in- and output and pump function description.....	22
Analog Indgang (AI1).....	23
Regulator function:	24
Flow interface:	25
Additional options:.....	25
Digital Inputs (I1 – I2).....	26
Digital outputs.....	27
Contact device via TCP/IP	29
Device settings / advanced settings.....	30
Reports and alarms:	30
Reverse Comm:.....	30
Show Status	33
Online status.....	33
Graphical and schematic view	34
Register list "quick-guide"	35
In- and output.....	35
Analog input	35
Digital input	35
Digital output.....	35
Pump.....	35
Pump control.....	35
Time and date.....	35
System information.....	35
Levels.....	36
External gauges.....	36
Alarm and Warning	36
Pumpword: Register 70	36
PUMA status: Register 92	37

PUMA

About PUMA

PUMA pump control is a universal compact one-pump control with the possibility of communication. PUMA can operate both 1-phase or 3-phase pumps up to 12A (5.5KW).

PUMA uses either a level switch or standard 4-20mA analog level meter, where it measures the level in the well, and starts and stops the pump automatically. PUMA has integrated standard functions for inlet flow calculation, flow- and capacity calculation as well as high level control via a high level switch.

PUMA has a unique function for current measurement on all 3 phases as well as phase sequence detection. PUMA has 2 digital inputs for high level switches or the like. Aswell as 2 digital outputs for general alarm etc.

PUMA is constructed with a two-part impact resistant IP65 encapsulated housing. The PUMA cabinet can easily be mounted on a wall, in street cabinets and other enclosures due to its compact size of only 23cm in width. The PUMA housing is designed for easy connection via bottom-mounted fittings and a combination of screw terminals and spring clamps.

For daily operation, PUMA has a 2.4 "OLED display in the front and 4 user interface buttons. PUMA can be delivered with a built-in communication interface, such as either a 4G or NB-IoT modem. PUMA uses Modbus TCP / IP protocol.

PUMA is configured with the common PC software- AcowaZoo. This is done locally via USB connector or remotely via 4G modem connection. Via the built-in USB connector in the PUMA controller, it is possible to perform firmware update.

Puma is Danish developed and produced and complies with all specifications for electronics components that must be placed in difficult environments.

Functions:

- Built-in GSM/GPRS or NB/IoT modem, thoroughly tested communication for to different SCADA-systems.
- Modbus TCP/IP
- Built-in graphical 2.4 "OLED display.
- Validated flow calculation, where the "true" capacity of the pump is calculated
- Inlet flow calculation with load profile at pump station.
- High level control function via level switch, if the pressure transmitter is faulty.
- Built-in power bank, which keeps the control active after voltage failure, so that an alarm is given to the SCADA-system.
- Option of varied starting level, so that build-up of fat edge is avoided
- Configuration of PUMA via ACOWA-ZOO software, both locally or via TCP connection.

PUMA and advanced flow calculation:



When specifying the physical design of the well, the PUMA controller subsequently calculates the following data, which are available via the SCADA-system. It is therefore possible to get a load and performance profile of the pumping stations, without having to invest in external measuring equipment for the individual stations.

The PUMA controller finds the longest pump cycle for each day, calculates the capacity of the pump based on inlet time and pump-out time and saves this value as the candidate of the day. After a custom number of days, the candidates are evaluated, and the PUMA control selects the most representative values for the pumps' capacities. This allows the PUMA controller to calculate the amount pumped out.

- Current outlet flow
- Out pumped quantity (Total, yesterday & today)
- Pump capacity
- Current inflow flow
- Inflow quantity (Total, yesterday & today)

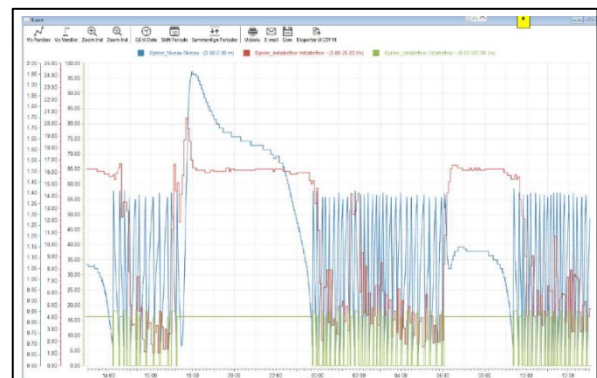

The image is an example of a curve showing the current level (blue), outlet flow (green) and inlet flow (red).

Non-revenue water

The PUMA controller is also able to calculate the inlet flow, which i.e. can be used to assess the amount of non-revenue water in the system, as you have a clear and correct load profile of your pumping station. The curve to the right shows the direct relationship between precipitation and the inlet flow to the pumping station. Non-revenue water can in all probability be found at this separately sewered wastewater station. Since an increased inlet flow in this example to the right relates to a precipitation event, in this case it is either a direct diversion from the fortified area or a faulty connection. Had the event occurred

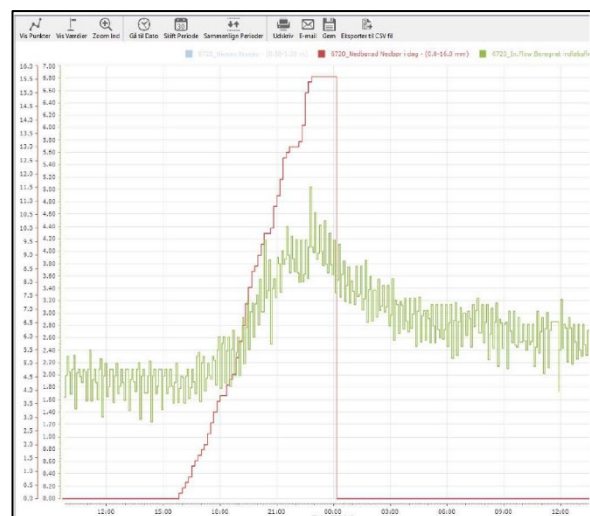

e.g. 3-4 hours before the increased inlet flow, there would be an indirect inflow, which in most cases is due to drains or seepage of groundwater into the system.

With the PUMA pump control, this data will be available for all pumping stations. It will therefore be possible to identify the areas and stations where an effort should be made, as you can now compare the individual stations in a specific area 1:1.

Safety instructions

These safety instructions give a quick overview of the safety precautions to be taken in connection with any work on this product. Observe these safety instructions during handling, installation, operation, maintenance, service and repair of this product. Keep these safety instructions at the installation site for future reference.

Connecting the pump supply and power supply



Danger
Electric shock
Death or serious personal injury

- In case of an insulation fault, the fault current may be a DC or pulsating DC. Observe national legislation about requirements for and selection of Residual Current Device (RCD) when installing the control unit.



Warning
Electric shock
Death or serious personal injury

- Switch off the power supply before making any electrical connections. Make sure that the power supply cannot be switched on accidentally.
- Remember to indicate where the main switch is located by placing a label or similar marking on the control unit.
- Electrical connections must be carried out according to the wiring diagrams.

Intended use

The product can be configured for the following purpose:

- Pumping out sewage wells or reservoirs.

The product can be used for the following applications:

- Network pumping stations
- Main pumping stations
- Commercial buildings
- Municipal systems.

The product is only intended for use in control panels. The product must not be exposed to strong solvents or oil-containing liquids

Servicing the product



Warning
Electric shock
Death or serious personal injury

- Switch off the incoming power supply before you start any work on the product or connected pumps.
- Make sure that the power supply cannot be switched on accidentally.

Replacing the fuse



Warning
Electric shock
Death or serious personal injury

- Switch off the power supply before making any electrical connections.
- Make sure that the power supply cannot be switched on accidentally

Fault finding the product



Warning
Electric shock
Death or serious personal injury

- Switch off the power supply before making any electrical connections.
- Make sure that the power supply cannot be switched on accidentally

Disposing of the product



The crossed-out wheeled bin symbol on a product means that it must be disposed of separately from household waste. When a product marked with this symbol reaches its end of life, take it to a collection point designated by the local waste disposal authorities. The separate collection and recycling of such products will help protect the environment and human health.

Installation

Power supply

PUMA must be connected to the supply voltage according to the specifications below.

Voltage supply	1x230V AC or 3x400V AC +10%/-20%
Frequency	50/60Hz
Input power consumption	0,004 -> 0,06A
Max supply fuse	16A
IK max	6kA
System grounding	TT

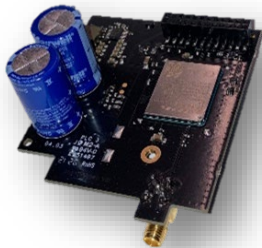

PUMA's communication module is equipped with a built-in power bank and can send voltage failure alarms if the primary power supply stops working.

WARNING! The unit must not be disassembled until the power bank is switched off.

Physical measurements

For installation of PUMA, the following dimensions may be necessary.

Dimensions (W x H x D)	W=237mm x H=248mm x D=98mm
Weight	1350g
Wire connection	0.5 – 6 mm ²
Vibration (sinusoidal)	10-500Hz, 1G
Free fall drop	30cm
Enclosure class	IP65

Environment

Humidity	10% - 95% non-condensing air
Operating temperature	-20°C to +50°C
Storage temperature	-20°C to +60°C

Built-in power supply

PUMA has a built-in power supply which is intended for voltage supply of sensors and input and output signals. Power supply output + V:

Output voltage	24V DC
Output current	Max 100mA
Tolerance	+/- 20%

Analog input

PUMA is equipped with one analog input 0...20 mA / 4...20 mA.

Number of analog mA inputs	1
Electrically insulated	No
Measuring range	0/4 – 20mA

Input impedance	Aprox. 100 Ω
Measurement accuracy	+/- 1% of FS
Signal range	0-24mA
Signal frequency	Max 100 Hz
Cable/signal length	Max 30m

Digital inputs

PUMA is equipped with 2 digital inputs.

Number of digital inputs	2
Electrically insulated	No
Digital signal	Low < 1V / < 2,5uA High > 12V / > 4mA
Signal frequency	Max 100 Hz
Cable/signal length	Max. 30m

Digital outputs

PUMA is equipped with 2 digital relay outputs.

Number of digital outputs	2
Electrically insulated	Yes
Insulation voltage	4 KV
Relay type	Reley outputs
Cable/signal length	Max 100m
Constant load	max. 2A@230Vac - AC1 max. 100W@230Vac - AC3 max. 1A@30 VDC
Minimum current	5 mA @ 10 V
Maximum start-up current	6A eller 10A@20ms.
Switch speed	Max 10 Hz

Pump

Data for connection of pump.

Supply	1-phase 230V AC or 3- phase 400V AC
Pump size	Max 5,5kW
Maximum power consumption	12A
Motor protection	3-phase electronic current measurement
Cable/signal length	Max 10m

Operation

Overview

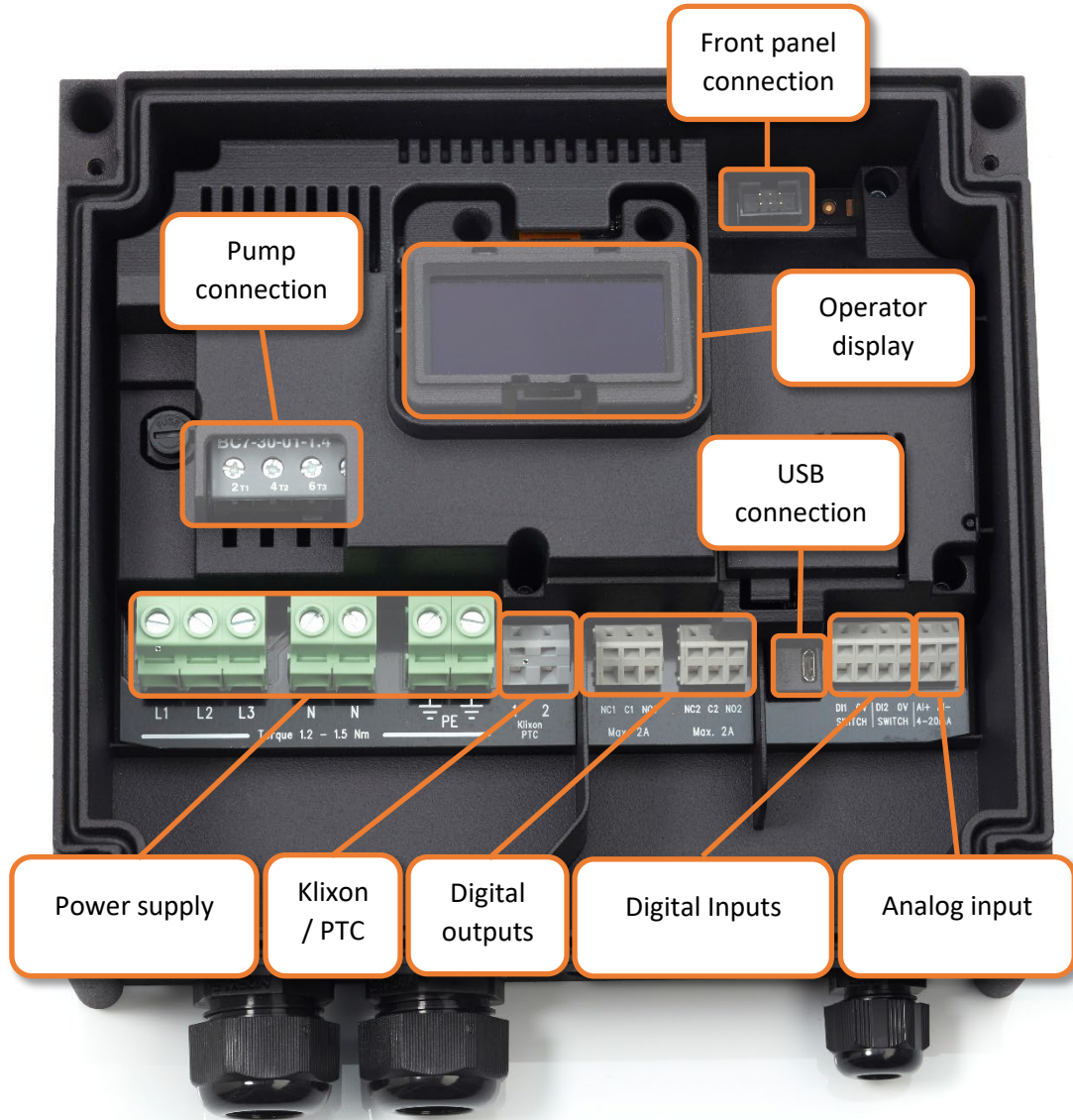

Installation guide

1-phase pump

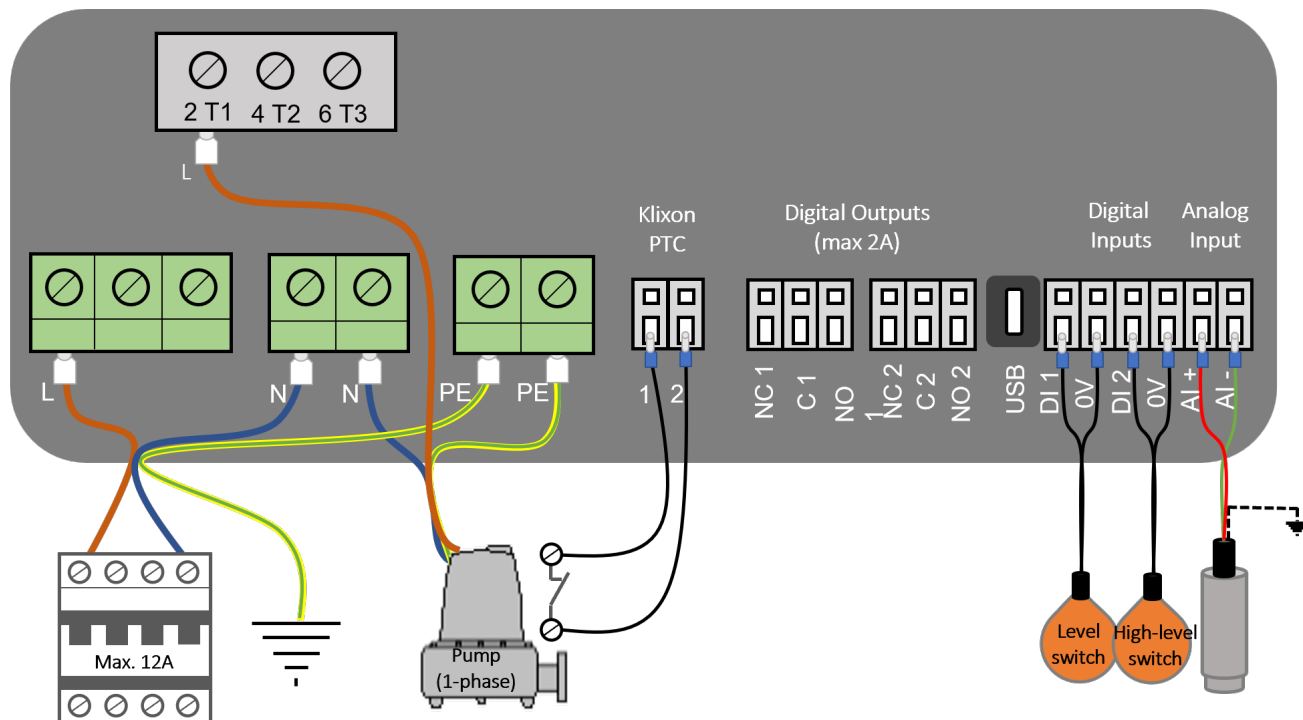

3-phase pump

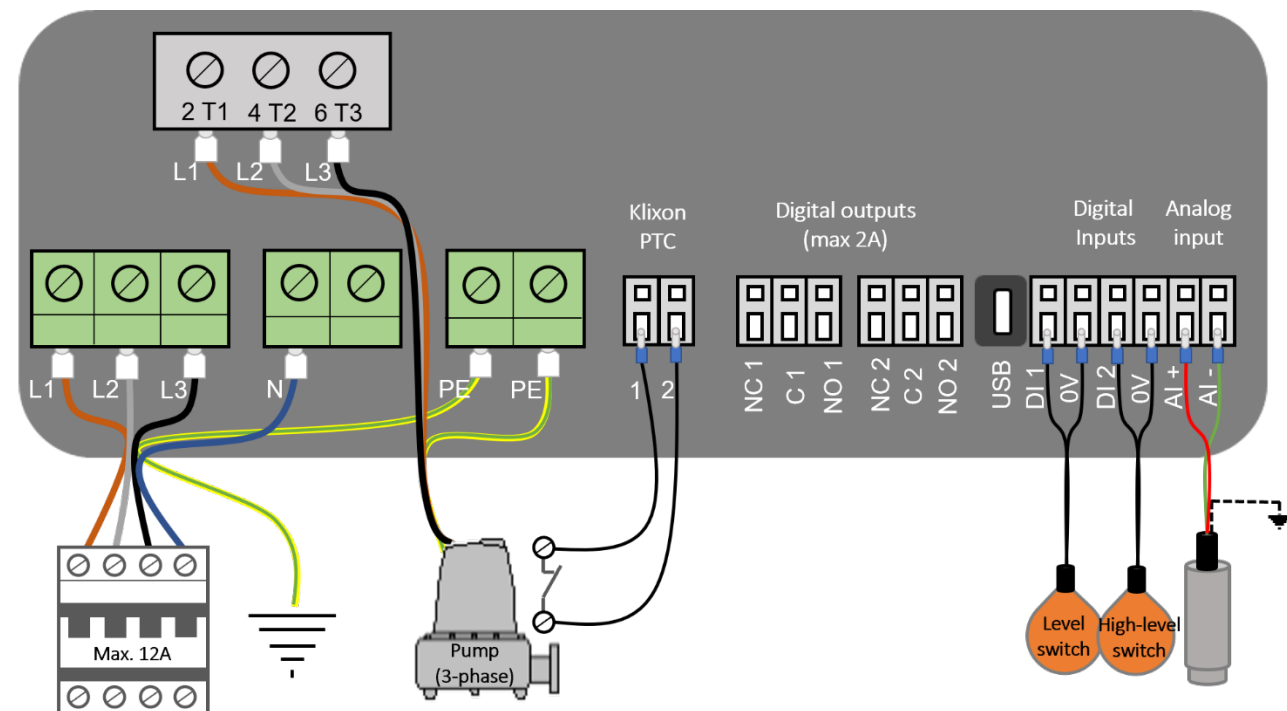

Display

Display 2,4" OLED and operation

PUMA comes with a 2.4 "OLED display. Display structure is intuitively and with fast user understanding and can be operated via push buttons on the front of the panel.

There is a pause screen which means that the normal screen display is deactivated after 5 minutes and goes into a pause screen where the level is displayed in different places on the screen.



The "Home" button is used to go to the main screen and boot the display in sleep mode.

Up / Down maneuvering in menu structure, as well as settings options.

If both buttons are used at the same time, the pump runs manually until the buttons are released again. (the function only works in the main menu picture)

"Enter" is used to access submenus, or to confirm new input selection.

Menu structure for 2,4" OLED Display

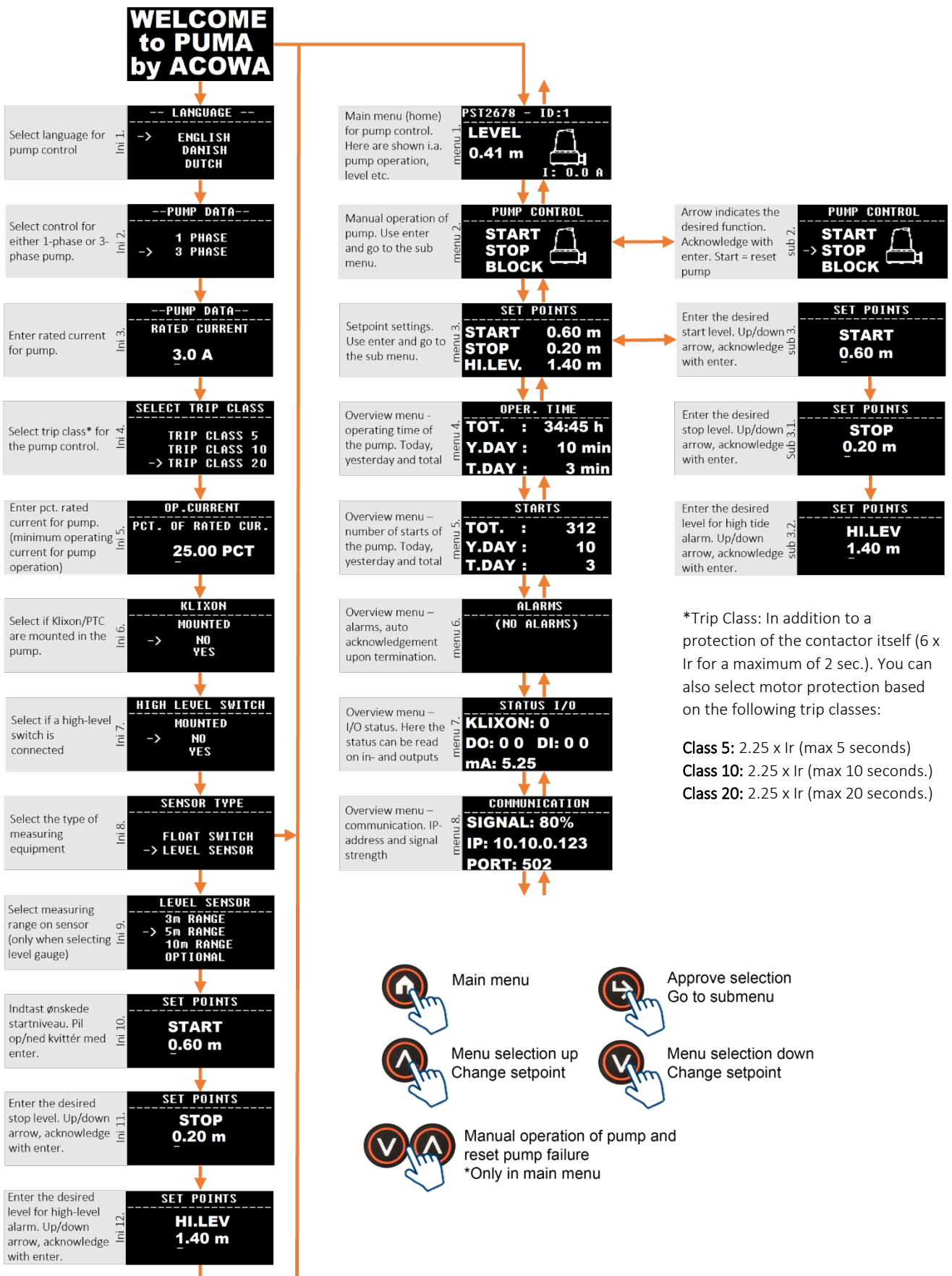

AcowaZoo

Connecting to a PC

USB connection

PUMA connects to the PC via a Micro-USB connector on the side of the device. The AcowaZoo will then connect to the device for configuration. When the AcowaZoo program starts, it will continuously try to establish contact with a PUMA device via USB connection.

TCP Connection

To connect to AcowaZoo-Tool via TCP, it must first be set to the correct TCP settings (IP Address, Port, APN). This is done in the AcowaZoo via the USB port. Once the PUMA is configured correctly, then it can be accessed from the AcowaZoo via TCP.

AcowaZoo Installation

Driver installation

Before installing AcowaZoo on a computer running Windows 7 or Windows 8, an additional driver file for communication via the USB port must be installed.

Right-click on the file "fsl_ucwpx.inf" and select "install". Windows will ask for permission to install. The file is located in the "driver" folder under the " AcowaZoo-Tool " folder.

Program installation

AcowaZoo can be installed on computers running Windows 7, 8, or 10 or newer. Run the program "**AcowaZooSetup.exe**" ("AcowaZooSetup_32bit.exe" on 32-bit operating systems) and follow the on-screen

instructions:

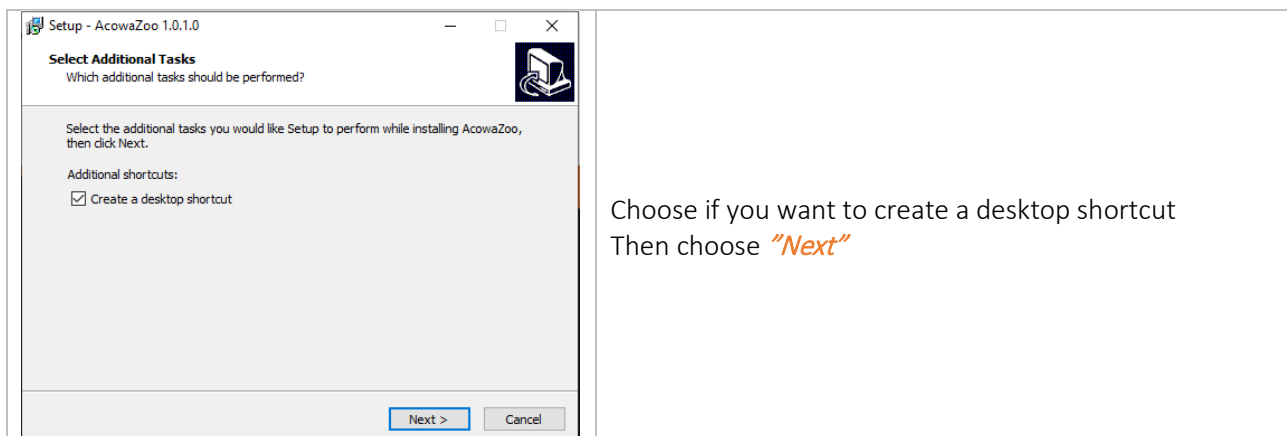

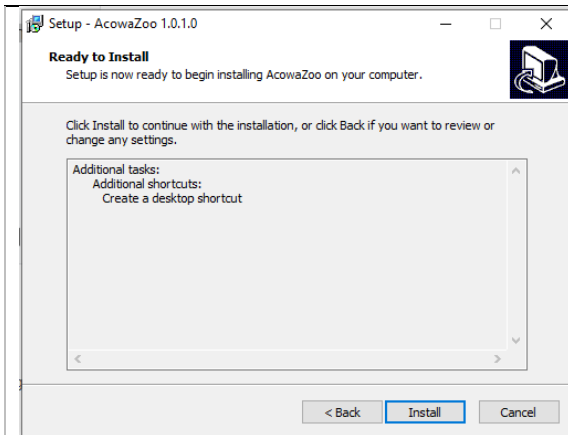

Choose *"Install"*

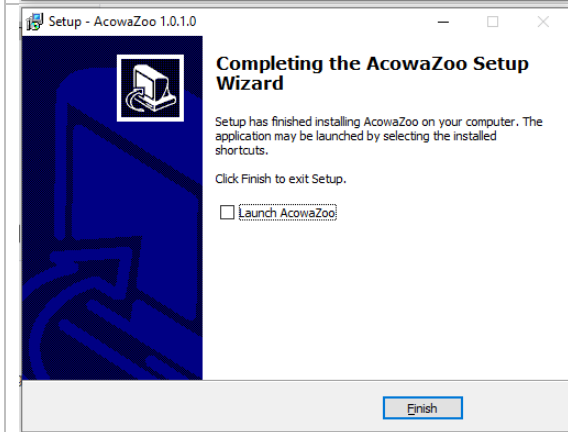

Choose whether to start ACOWA ZOO-Tool after installation.
Then choose *"Finish"*

Configuration



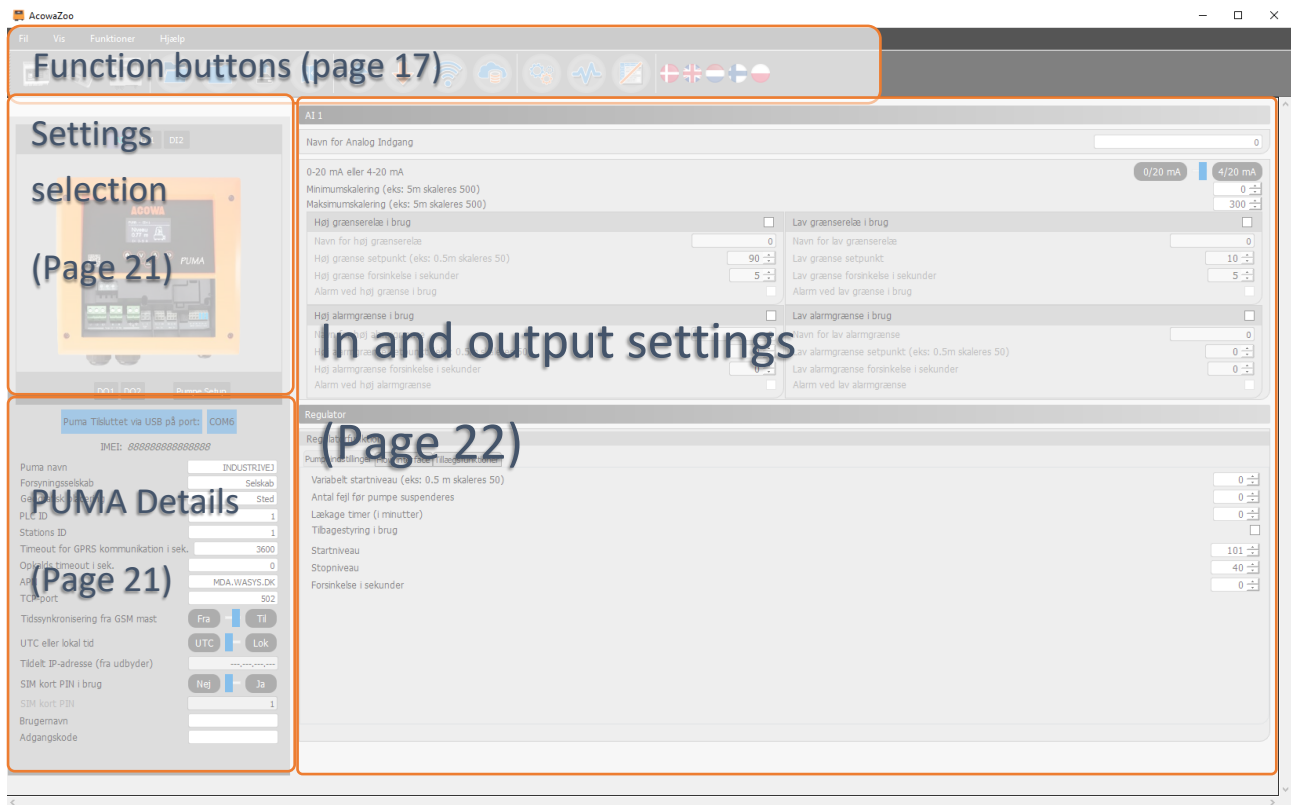

AcowaZoo user interface

Overview



Function buttons

Functions associated with writing and reading from PUMA and disk, as well as contact with PUMA via TCP.

	Open Local Config File Load configuration from hard drive, USB drive, etc.
	Save Local Config File Save configuration on hard drive, USB drive, etc.
	Load Default Configuration Select and load a typical PUMA configuration (control of 1 or 2 pumps, groundwater lowering, etc.)
	Backup function Mirrors the counters etc. in the PUMA controller. (Is used for updating or replacement of the modem)

	<p>Load Config from Device. Load settings from the connected PUMA device.</p>
	<p>Write Config to Device. Writes the current settings to the connected PUMA device</p>
	<p>Establish TCP connection to the device Establishes TCP communication with a PUMA device (With the 2G PUMA version it disconnects any USB connection)</p>
	<p>Device settings Advanced settings. (Further description on page 28.)</p>
	<p>Show status. Supervision and status bits. (Further description on page 30.)</p>
	<p>Toggle Graphical and Schematic view Toggle between displaying graphical menu settings and displaying schematic settings (overview of ModBus registers in PUMA device)</p>
	<p>New AcowaZoo version available. Update AcowaZoo firmware (Is only shown when a newer version is available)</p>
	<p>Language Options Select application language.</p>

Function menu

Files

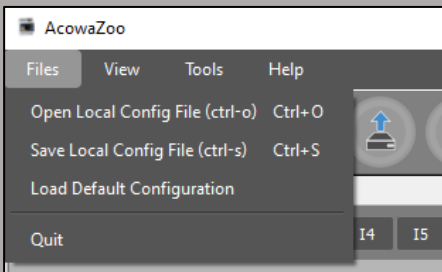
	<p>Open local config file: Ability to load previously saved configurations</p> <p>Save local config file: Ability to store configurations locally.</p> <p>Load default configuration: Loads a default file that you can continue working on.</p>
---	---

View

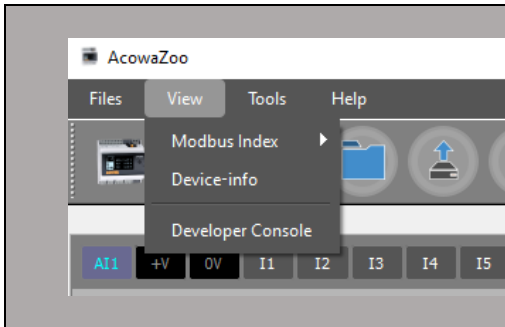

ModBus index:

Here it is possible to choose either register view or address view. The selected parameters will then appear next to each function. See the example below.

Device info:

Displays the firmware version

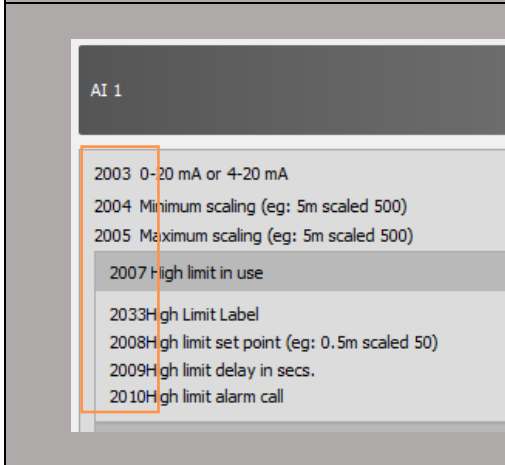

ModBus registers:

The selected parameters are displayed next to each function. The figures change in relation to choice of address or registers

Tools

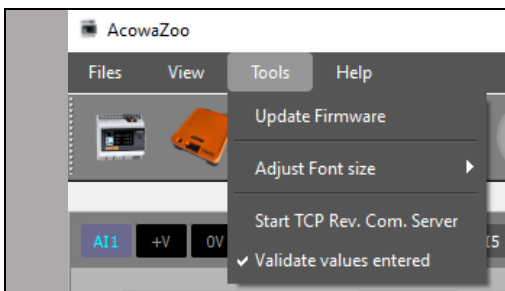

Update Firmware:

Here, device firmware is updated. See below for instructions.

Adjust Font Size:

Here, font size can be enlarged or reduced.

Device firmware update.

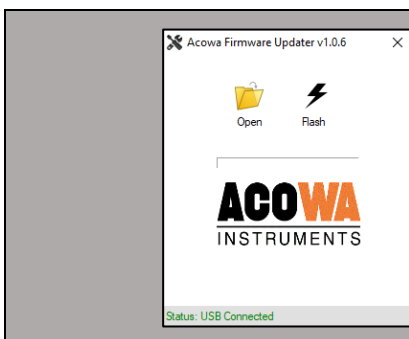

Acowa firmware updater:

When choosing a firmware update, AcowaZoo shuts down and opens an update software instead. Connect the desired device via the USB port.

The status will change to: USB connected.

Then press the folder "Open"

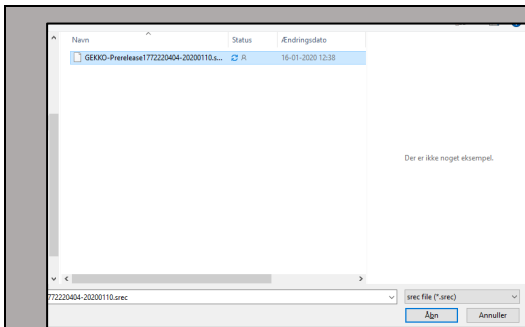

Select the required firmware file and press "Open"

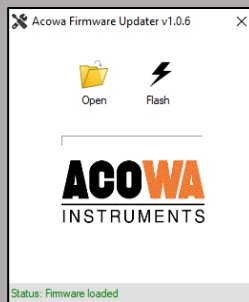

The status is then changed to: Firmware loaded.

Now click on the "Flash" icon

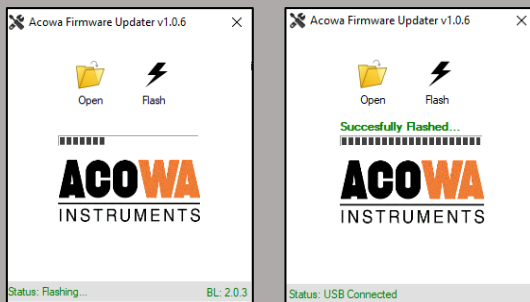

The status is then changed to: Flashing.

When the device is updated, it will state: Successfully flashed. The program then has to be closed down and AcowaZoo is to be reopened.

Help

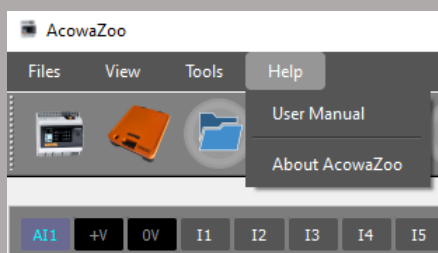

User manual:

Opens a user manual

About AcowaZoo:

Displays the version version of AcowaZoo

Settings selection



Here you select which part of the PUMA device's settings is to be displayed in the settings window on the right.

Pump Setup: Pump setup. The function menu for the 1st start-up of PUMA

AI: Analog input settings

DI1 - DI2: Settings for inputs 1-2

DO1-DO2: Settings for outputs 1-2

PUMA details

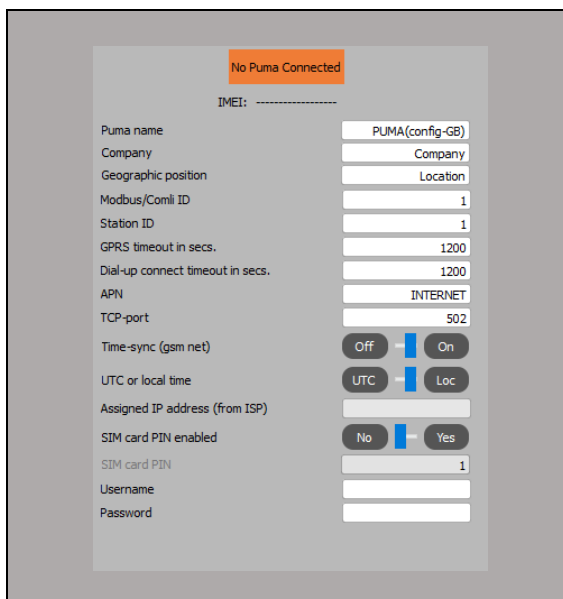

Here you are notified if a PUMA is connected and what types of connection are involved:

- USB on COM port
- TCP at Ip address / port

At the same time, details of the PUMA device name and location are displayed/set, as well as communication settings.

- APN
- TCP-port

Pump setup

At the first start-up of the PUMA pump control, an initialization sequence will start on the display. If you subsequently want to change this, this can be done in the Pump Setup menu.

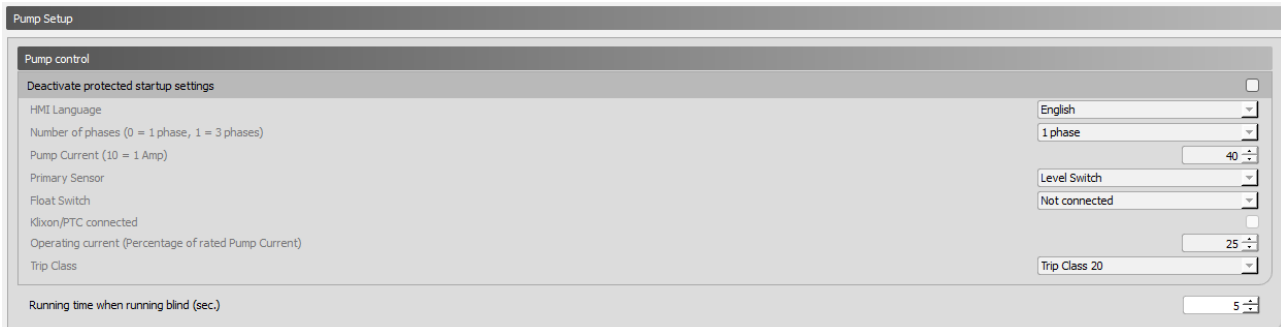
Disable write protection start-up parameters: By ticking the menu you can access the menu.

HMI language: Here, the preferred language is selected on the display

Number of phases: Here you choose whether you want to control a 1-phase or 3-phase pump.

Pump current: Here you enter the rated current of the pump (10 = 1 amp.)

Primary sensor: The PUMA pump control can be controlled via a level switch or via an analog level meter. Here, the choice of primary sensor for pump control, analogue measurement via level gauge or digital via level switch or similar is selected.

High-level switch: If the pump control is to be supplemented by an extra high-level switch, select this here.

Klixon/PTC connected: If the engine is equipped with either Klixon or PTC, check with a tick.

Percentage of rated pump current: Here the minimum acceptable current for verification of operation of the pump is stated in%.

Running time when running blind (sec.): Here the lag time is specified in seconds when a level switch has been used for high-level control.

Trip Class: In addition to a protection of the contactor itself (6 x I_r for a maximum of 2 sec.). You can also select motor protection based on the following trip classes:

Class 5: 2.25 x I_r (max 5 seconds)

Class 10: 2.25 x I_r (max 10 seconds.)

Class 20: 2.25 x I_r (max 20 seconds.)

Settings for in- and output and pump function description

Here, settings for inputs and outputs as well as other logic in the PUMA control are described. The individual pages are selected in Settings options for inputs and outputs, as well as pump function description.



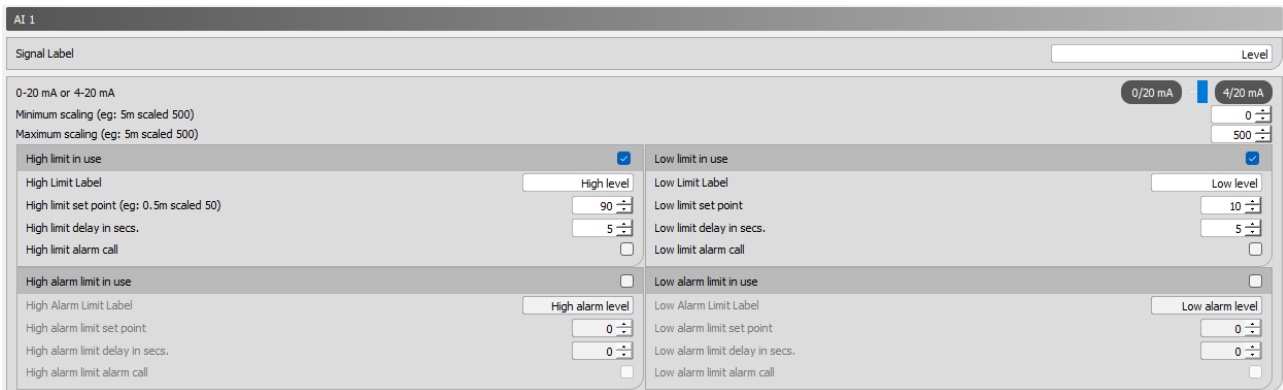

Analog Indgang (AI1)

The analog input on the PUMA controller is a standard 0-20 / 4-20 mA input, to which a pressure transmitter or other measuring equipment can be connected.

The input functions can be set in AcowaZoo when AI1 is selected in the Settings option. AI1 contains the following settings:

AI 1 Settings	Functions	Description
0-20mA or 4-20mA	Scaling input defined by measurement equipment	
Minimum scaling	Minimum measurement reading value	With 2 decimals (500 = 5,00)
Maximum scaling	Maximum measurement reading value	With 2 decimals (500 = 5,00)
High limit in use	Activates high limit functions	0=disabled, 1=activated
High limit label	Naming the high limit value	Used in alarm list and SMS
High limit Set point	Defines high limit value	
High limit delay in secs.	Signal delay	Stated in seconds
High limit alarm call	Activates alarm signal	0=Local signal, 1=alarm signal
Low limit in use	Activates low limit functions	0=disabled, 1=activated
Low limit label	Naming the low limit value	Used in alarm list and SMS
Low limit Set point	Defines low limit value	
Low limit delay in secs.	Signal delay	Stated in seconds
Low limit alarm call	Activates alarm signal	0=Local signal, 1=alarm signal

Scaling of AI1

It is possible to choose between 2 types of mA measurements. Either "0-20 mA" or the most common "4-20 mA". Min./Max. scaling points is entered at the desired resolution. For example, if a pressure transmitter with a measuring range of 0-5m is used, and you need to read the level in cm. Enter min. = 0 and max. = 500.

Limit relay values

Limit relay values can be configured for high/low limit levels. For both types of limits the function can be activated/deactivated, and the limit relay can be named with a label used as text in an alarm list and in SMS alerting.

Values can be set to which level the high/low limit relays are activated, and a delay can be attached, so that a limit value must be exceeded for a given time before the signal is registered as active. It is possible to choose whether to send the signal as an alarm or to act as a local alarm..

Regulator function:

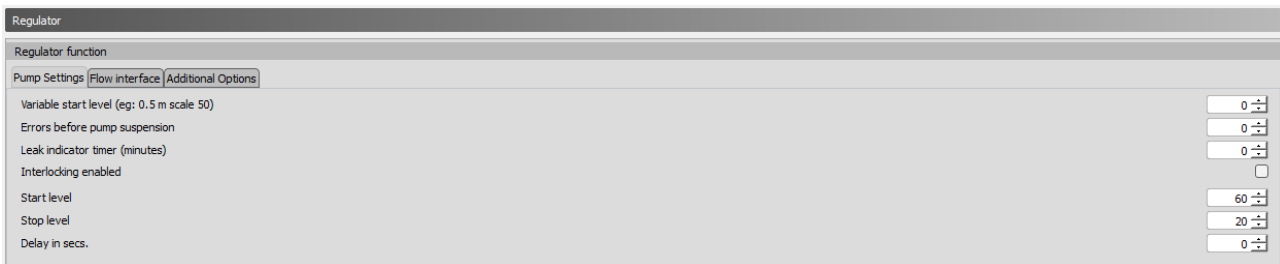

Under the settings for AI1 is the regulator function. Here, the most common parameters for the pump control function are configured.

There are additional functions that can be selected by clicking on the corresponding tabs "Pump settings", "flow interface" and "additional options".

Variable start level: By setting a variable start level, you allow the PUMA control itself to select the level for start, within the limits you have defined. For example: The start level is set to 1m and the variable start level is set to 0.1m. When the level in the station reaches 1m, the variable start is initiated which can be depending on 1cm to 10cm. Thereby the pump does not start in the same place twice in succession. The function can i.a. used in connection with the reduction of fat edge formation.

Antal fejl før pumpe suspenderes: Errors before pump is suspension: The PUMA control uses auto-acknowledgment of all faults. If the same error occurs repeatedly, all depending on the value entered - for example overcurrent on the pump, then the pump is suspended, and you must manually reset the error. If the setting selection is set to 0 then the pump is never suspended.

Leak indicator timer (minutes): Can be used in connection with leakage faults on the inlet pipe. If the setting choice in minutes exceeds the time between 2 pump starts, then it is assumed that there is a reduced inlet to the pump station and thereby there is a risk of a leak on the inlet pipe. This is a warning and not an alarm that can be read on the PUMA status word register 92: bit 12. The PUMA control does nothing but report the warning, the error has no functional consequence in the control.

Interlocking enabled: Approves that the pump control can interlocked from either SCADA system or via SMS. Can be put in PUMA status word register 92: bit 20 and read in PUMA pump word register 70: bit 12.

Start level: Here you enter the desired start level for the pump

Stop level: Here you enter the desired stop level for the pump

delay in seconds: The function is used if you want a delayed start-up of the pump. The pump start is delayed, the entered value in seconds, after the start level is reached. The function is used i.a. in connection with the mixer function, where you want a function where first the mixer starts up and then it must take some time before the pump is started.

Flow interface:

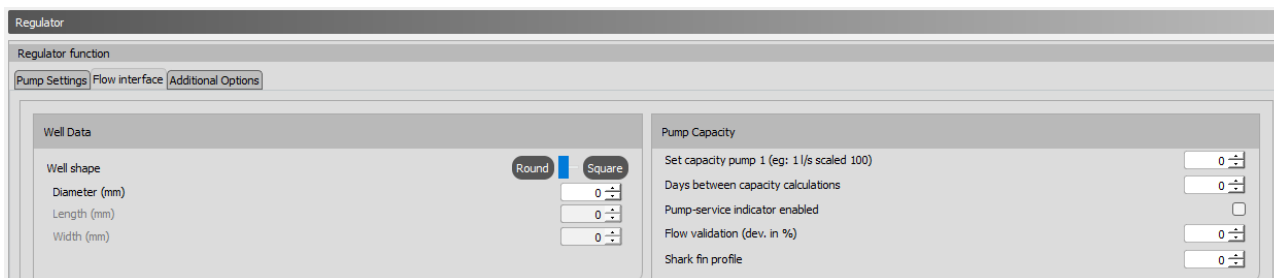

With very few settings, one can get the PUMA controller to perform a validated flow calculation.

Well data: Here, the design of the well, round or square, is selected, then either diameter or the dimension of the sides in mm is entered. This determines the surface area, and the PUMA control calculates on the basis of start / stop levels how much is pumped out during a pumping cycle. (For correct flow calculation, the start level of pumps must be below the inlet pipe and the stop level of the pump must be above the banquet)

Pump capacity: If you know the capacity of your pump, you can help the PUMA controller on its way by entering it. Otherwise, the number of days entered in the next value field will elapse before data is available for the capacity calculation

Days between capacity calculations: Number of days between the calculations of capacity. Typically set to 5 days. If the input value is equal to 0, then the PUMA controller will not perform capacity calculations.

Flow validation: Used in connection with a possible deviation in the measurements of the capacity calculations. The entry is a deviation in%.

Example: If you enter 30 in the input field, the PUMA control will approve all pumping cycles that deviate by less than 30% compared to the previous one. All deviations above 30%, it will reject and not include in the capacity calculations. If the input value is equal to 0% then the PUMA controller will not perform capacity calculations.

Shark fin profile: If this value is set to 1, then PUMA ignores the pump control from the inlet profile when making the capacity calculation for the pump. This function is typically used in situations where the inlet flow is not constant, for example when pumping in from other stations.

Additional options:



It is possible to select 4 different maintenance functions. The functions are activated by ticking the individual functions.

Enable Pump exercise: At small pumping stations, where the supply may depend on the seasons such as wells in the vacation homes, it can be helpful to get the pumps exercised at regular intervals. With PUMA you can select this function and determine the time of day for exercise (for example Value 700 = 7:00), you can also choose how many days between the last regular pumping to the next pump exercise and you can enter the duration in seconds of exercise.

Daily emptying enabled: It is possible to have PUMA run an emptying function at a fixed time of day. You put a check mark in "Daily emptying on/off" and enter the desired time of day. For example, the value 915 will be perceived as the time 9:15.

Flush function enabled: The flushing function provides an opportunity to fill up your station extra, thus providing an extra volume for flushing your pipe system. You simply enter hours between rinsing and the desired level of extra filling.

Activate depth pumping: PUMA pump control also supports depth pumping. Here you choose the time of day and how many days should pass between each depth pump.

Example: Time of day for deep pumping is set to the value 900 = 9:00, days between deep pumping are set to 7 = 7 days. Furthermore, it is possible to define whether the deep pumping should take place as soon as the selected time occurs or whether the pump control must wait for a further start level first. This is done either at a value = 0 (at the time selected) or value = 1 (time selected, waiting level for start). Then select the lead time you want (depth pumping), drive after stop stop 20 = 20 sec. The control will then every 7 days at 09.00 drive down to stop level and continue for another 20 sec. to clean the banquet.

Digital Inputs (I1 – I2)

I1-2 inputs on the PUMA controller are a standard digital input where "0" <5V and "1"> 12V. The input functions can be set in AcowaZoo when I1-2 is selected in the Settings option. I1-2 contains the following settings:



Settings for DI 1-2	Function	Description
Signal label	Name of the signal	Used in alarm list and SMS
Input 1/2 – function	Selection of predefined functions	
Normally open / closed	The polarity of the signal	
Delay for ON-state in secs.	Signal delay	Stated in seconds
Delay for OFF-state in secs.	Signal delay	Stated in seconds
alarm si	Activates alarm signal	0=Local signal, 1=alarm signal

Following functions for DI1-2 can be chosen:

Standard DI: Can be used to count pulses or examine the state of a desired digital signal.

Intensity: Used in connection with rain gauges, where you can read the following values: Total heart rate counter, today counter and yesterday counter. The values can be read on register adr. 256, 258, 260

Dry running: Used together a digital switch for indication of dry running conditions. When activated, the pump is stopped. Status for the dry run mode can be read in the Pump Status word 70 bit 23.

High-level switch: Used as a start signal for “running blind” control of pumps if, for example, the level transmitter is faulty. The condition of the high-level switch can be read on the PUMA status word 70: bit 26. (“Running blind” control function version 2, see page 32.)

“Running blind” pump control function: The pump control has 2 different internal functions for this.

Function 1. The “Running blind” control function is activated in case the level sensor falls outside its normal range <3.5 mA,> 23 mA. If this happens, it is assumed that the measuring equipment is defective, and the pump control will instead use the high-level switch to start/stop the pumps. In case of activation of the level switch, the pump starts according to the usual pump operation settings. The pump then run with a user-specified lead-in time.

Function 2. The hysteresis is the dead band that is around the last measured level, and if the level remains in this measuring range / dead band, for a user-selected time (in seconds), then this is a possible “Running blind” control situation. If the high tide switch is now activated, the “Running blind” control function is triggered and the pump starts and runs with a custom lead time. If the level changes out of the hysteresis range, the “time” is reset and a new dead band time must occur to make control ready for a possible emergency control.

Level switch: Used for starting / stopping the pump. Here, a given lead time for the pump before stopping is selected. (The lag time is set to 20 seconds by default)

Digital outputs

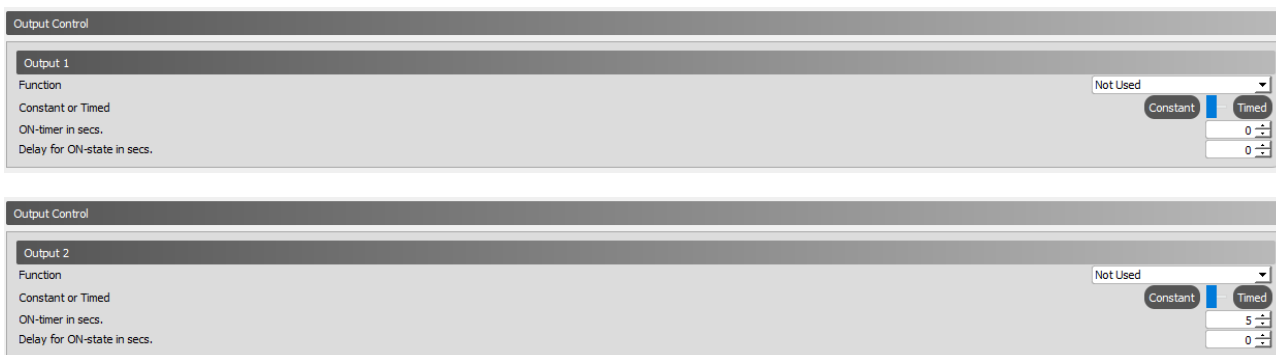

DO 1-2 are relay outputs that can be used for special functions.

The functions of the outputs can be set in AcowaZoo when DO1-2 is selected in the Settings option. DO1-2 contains the following settings:



Settings for DO 1-2	Function	Description
Function	Additional functions	See description below
Constant or timed	Choose if DO should be activated for a given period	On-timer stated in seconds.

Delay for ON-state in secs.	Signal delay	Stated in seconds
Delay for OFF-state in secs.	Signal delay	Stated in seconds

Functions for DO 1-2:

Not used: The digital output does not have a function associated with it, so the output can be used freely and can be controlled from SCADA.

Pump: The output is triggered when the pump is running, but is subject to its own delay and, if selected, on-time.

Pump error: Is activated if the pump is faulty.

General Alarm: Is activated if an active alarm is detected in the PUMA controller.

Dosing pump:

Output set to constant: The dosing pump runs at the same time as the pumping cycle.

Output set to timer: When the pump is running, the output will pulse. The time between each pulse is set in the parameter "Delay before ON in seconds", and the ON time of the pulse is set in the parameter "on-time for time control in seconds".

Example: At a "Delay before ON in seconds" set to 10 sec. and "on-time by time control in seconds" set to 5 sec. the dosing pump will start 10 seconds after the pump has started, run 5 seconds and stop, then start the sequence up again (wait 10 sec., run 5 sec.) This it will continue with until the pump reaches its stop level.

Pulse per volume unit: This function can give a pulse on a digital output based on a flow calculation, such as in overflow registration where the pumped quantity is calculated (the total amount can be read in address 250). This value can be used in conjunction with the quantity scaling in address 2794 and triggers the selected DO when there has been an increase in the total amount of the entered value for the quantity scaling.

Mixer:

Output set to constant: This function controls a mixer to stir the sump before a pump starts. The mixer activates an output when the level of AI1 > the starting level of P1 and stops again when the level < stop level of P1.

Output set to the timer: By selecting a lag time in seconds on the output, it is possible to make the mixer run for a selected time period and then switch off. If this function is combined with a delay in the start-up time of the pump, it will be possible to start up the mixer before starting the pump.

Example: If a delay of 30 seconds is set for pump start-up and a delay time of 1 min for the output, the function will work as follows. Start level is reached, mixer starts up (run time 60 seconds), 30 seconds later the pump starts up and it will then take another 30 seconds before the mixer stops again.

Contact device via TCP/IP

To activate the Device settings, click on the following symbol:
This results in the following window.

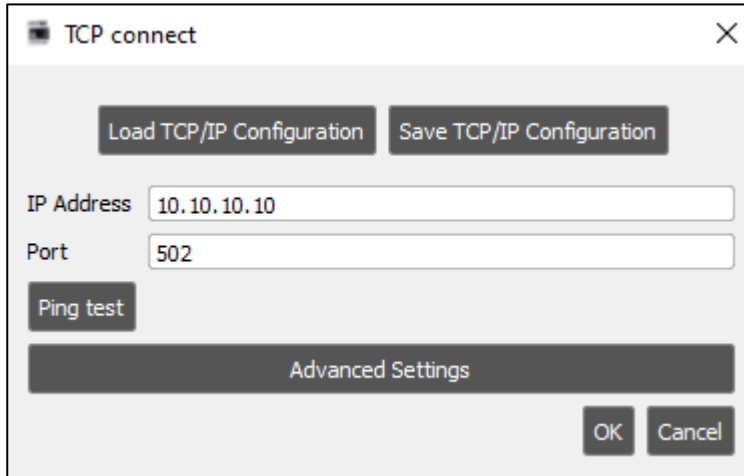

Enter the IP address and port to get remote control of PUMA via TCP/IP. Upon contact, the program located in the PUMA is retrieved. It is then possible to either make changes online in the PUMA or save a copy of the current program locally and then work on it.

If you want to save your IP configuration, this is done by selecting "Save TCP/IP configuration". Note, be aware that only the IP configuration is saved and not the rest of the PUMA setup. It is also possible to retrieve saved IP configurations using "Retrieve TCP/IP configuration"

Device settings / advanced settings

To activate the Device settings, click on the following symbol:
This results in the following window.



Reports and alarms:

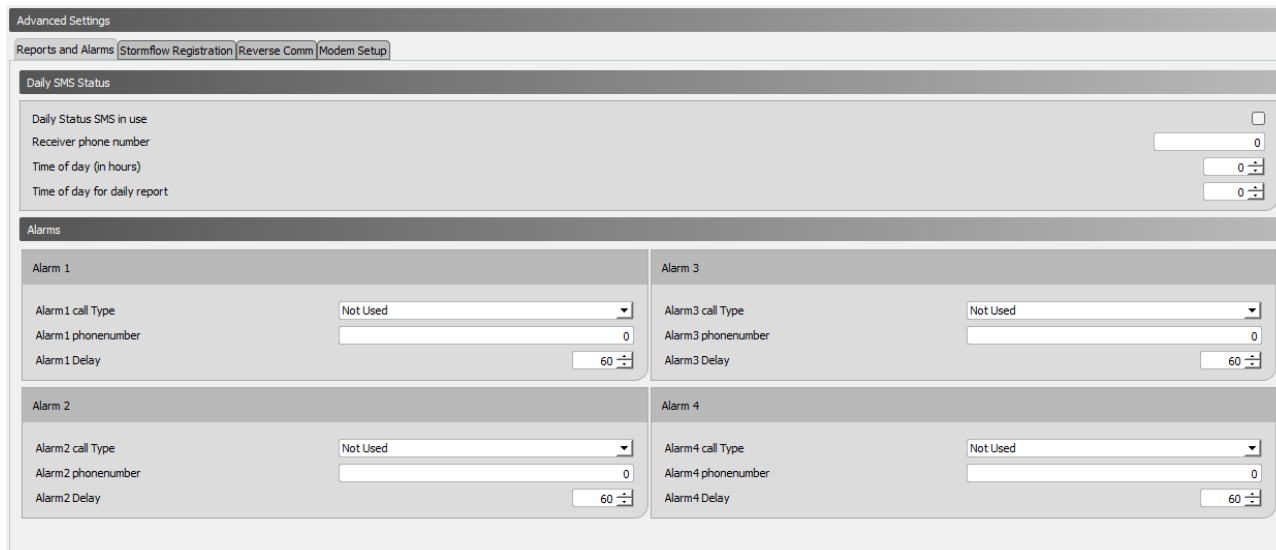

If the PUMA is used as a stand-alone device that is not connected to a SCADA system, it is possible to receive a daily status SMS and alarm SMS in case of an alarms.

For daily status SMS, the following parameter must be used: "Daily status SMS in use" to activate the function.

"Receivers Phone Number." There is only one user who can receive a status SMS.

"Time of day (in full hours)" you want a status SMS for example 9:00 pm. enter the value 9.

Alarms can be sent to 4 different recipients. You can use SMS or standard dial-up. You must enter a delay between each alert in the list. For SMS, a typical delay of 60 sec. When using dial-up, it will typically be 300 seconds.

Reverse Comm:



In cases where you do not have an MPLS network and you have the option of having a fixed public IP address associated with your network connection, you can make PUMA the TCP client and then connect to the SCADA system. The IP address of the public IP address is entered along with the desired TCP port. The PUMA will then establish a TCP connection to this address.

Stormflow registration:

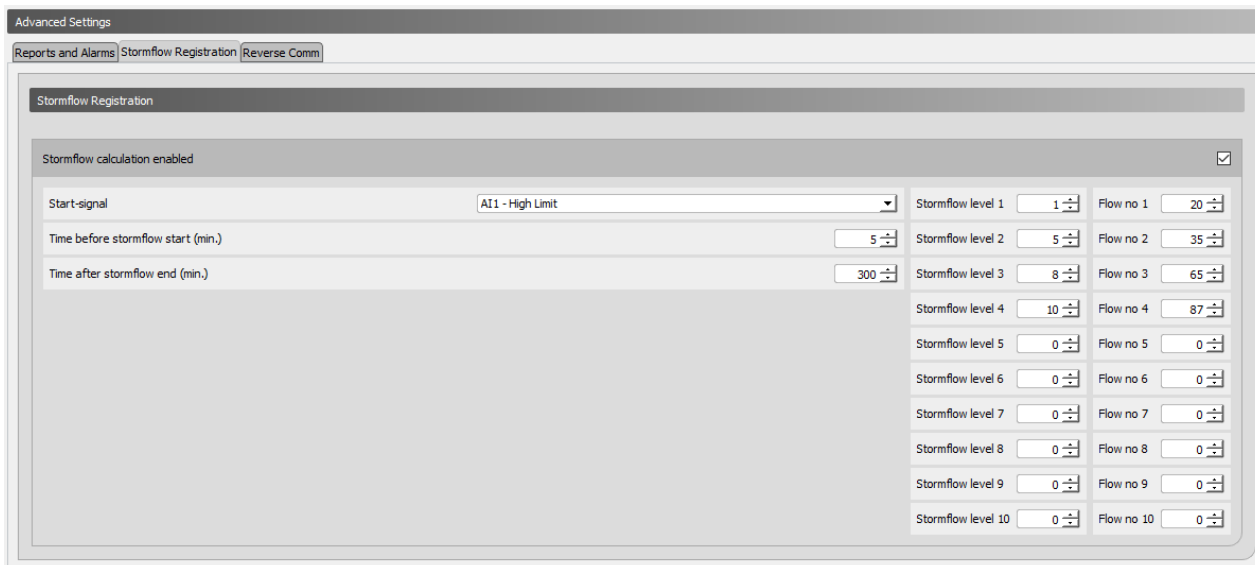

Stormflow calculation is used to record the number, duration and quantity of stormflow events.

The stormflow calculation can be used for either as a "True overflow" or "Conditional overflow".

The stormflow event "start" signal can be selected either as a high limit at AI1 or as a digital input on DI 1-6.

To use "True overflow", "Time before stormflow start (min)" and "Time after stormflow end (min)" are both set to 0.

If "Conditional" overflow is desired as shown in the picture, enter how long an overflow must be active before it is registered as a valid overflow, and how long an overflow must be completed before a new overflow is registered. In the example shown, the start time is set to 5 minutes. and an end time set at 5 hours.

The table is filled with a column for levels and a column with the flow value that matches the entered level.

The overflow levels are entered in the same unit as the level measurement on AI1 (typically in cm) and the flow is typically entered in m³/h. if you want the result with for example 1 decimal the flow values are multiplied by 10 in the table.

NOTE: it is important to start with a data set in the table that is NOT (0,0) as the PUMA perceives (0,0) as being the end of the table.

Operation data can be found in the following addresses:

Address	Description	Data type	Read/Write
206	Overflow current flow (m ³ /h)	u32	R
208	Number of overflows total	u32	R/W
210	Number of overflows today	u32	R/W
212	Number of overflows yesterday	u32	R/W
214	Duration of overflow today (seconds)	u32	R/W
216	Duration of overflow today (seconds)	u32	R/W
218	Duration of overflow yesterday (seconds)	u32	R/W
220	Overflow volume total (m ³)	u32	R/W
222	Overflow volume today (m ³)	u32	R/W

Address	Description	Data type	Read/Write
224	Overflow volume yesterday (m3)	u32	R/W

Show Status

Online status

To activate the Online window, click on the following symbol:



This results in the following window.

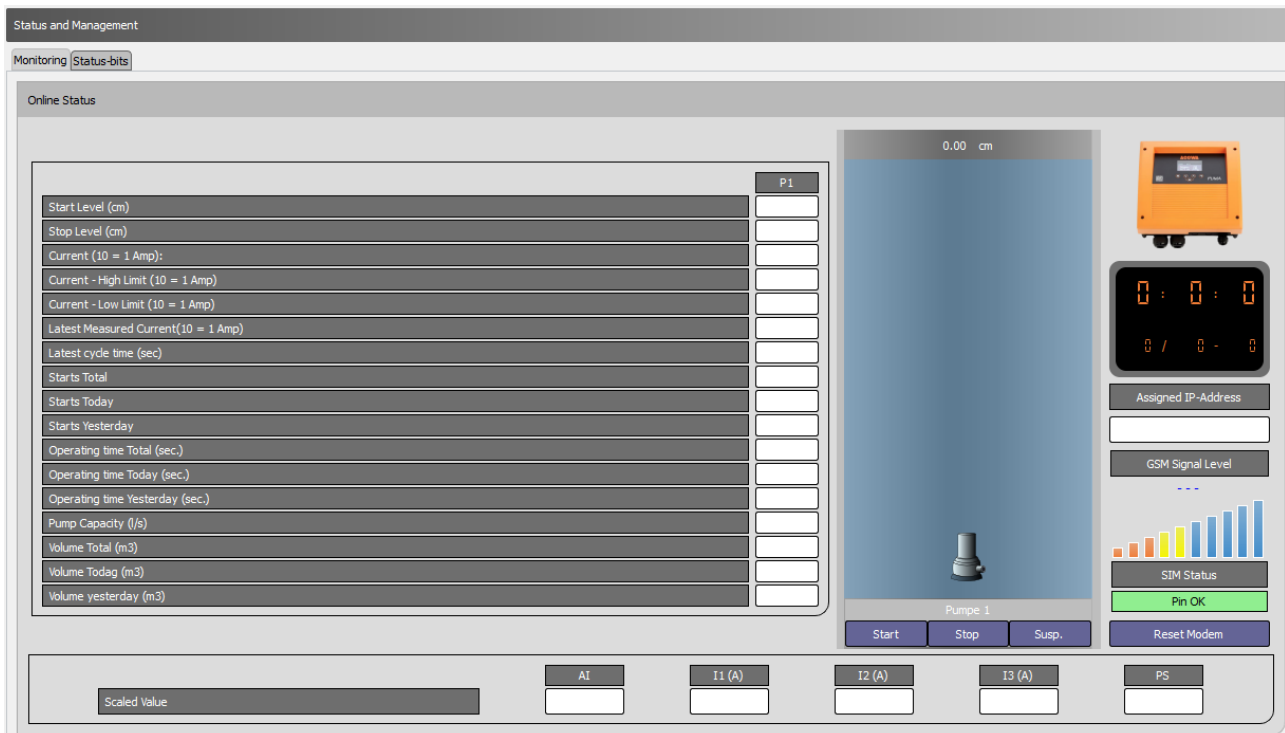

The screenshot shows the 'Status and Management' interface with the 'Monitoring Status-bits' tab selected. The 'Online Status' section is active, displaying a table of registers for Pump 1 (P1) and a central well level display showing 0.00 cm. The right side of the interface features a digital clock, IP address field, GSM signal level indicator, SIM status, and a 'Reset Modem' button. The bottom of the screen displays a 'Scaled Value' field and five current (AI, I1 (A), I2 (A), I3 (A), PS) readouts.

Register Name	P1
Start Level (cm)	
Stop Level (cm)	
Current (10 = 1 Amp)	
Current - High Limit (10 = 1 Amp)	
Current - Low Limit (10 = 1 Amp)	
Latest Measured Current(10 = 1 Amp)	
Latest cycle time (sec)	
Starts Total	
Starts Today	
Starts Yesterday	
Operating time Total (sec.)	
Operating time Today (sec.)	
Operating time Yesterday (sec.)	
Pump Capacity (l/s)	
Volume Total (m3)	
Volume Today (m3)	
Volume yesterday (m3)	

In the left frame, standard registers are displayed for the pump control, such as start/stop levels and operating parameters.

In the middle, well and pumps are shown, and it is possible to force start stop or block the pumps with the command buttons under the picture of the well.

On the right side, the clock in the PUMA can be read, as well as the IP address and signal strength. It is possible to set the clock in the PUMA by clicking on the window over time. You can also reset the modem in the PUMA by clicking on the "Reset Modem" button.

In the bottom of the screen the scaled value of AI and V1-6 is displayed.

Graphical and schematic view

To activate the graphical and schematic view window, click on the following symbol:



This results in the following window.

Register	Register Name	Min	Max	Description	Value	
1	2001	Modbus/Comli ID	0	247	Modbus/Comli ID	1
2	2002	Station ID	1	65535	Station ID	1
3	2003	AI - 0/20 mA or 4/20 mA	0	1	0-20 mA or 4-20 mA	1
4	2004	AI - 0% scale	-30000	30000	Minimum scaling (eg: 5m scaled 500)	0
5	2005	AI - 100% scale	-30000	30000	Maximum scaling (eg: 5m scaled 500)	500
6	2006	AI - Start-up time in seconds	0	60	Start-up time in seconds	5
7	2007	AI - high limit in use	0	1	High limit in use	0
8	2008	AI - high limit set point	-30000	30000	High limit set point (eg: 0.5m scaled 50)	90
9	2009	AI - high limit delay in secs.	0	60000	High limit delay in secs.	5
10	2010	AI - high limit alarm call	0	1	High limit alarm call	0
11	2011	AI - high alarm limit in use	0	1	High alarm limit in use	0
12	2012	AI - high alarm limit set point	-30000	30000	High alarm limit set point	0
13	2013	AI - high alarm limit delay in secs.	0	60000	High alarm limit delay in secs.	0
14	2014	AI - high alarm limit alarm call	0	1	High alarm limit alarm call	0
15	2015	AI - low limit in use	0	1	Low limit in use	0
16	2016	AI - low limit set point	-30000	30000	Low limit set point	5
17	2017	AI - low limit delay in secs.	0	60000	Low limit delay in secs.	5
18	2018	AI - low limit alarm call	0	1	Low limit alarm call	0
19	2019	AI - low alarm limit in use	0	1	Low alarm limit in use	0
20	2020	AI - low alarm limit set point	-30000	30000	Low alarm limit set point	0
21	2021	AI - low alarm limit delay in secs.	0	60000	Low alarm limit delay in secs.	0
22	2022	AI - low alarm limit alarm call	0	1	Low alarm limit alarm call	0
23	2023	AI - Label			Signal Label	
24	2033	AI - High Limit Label			High Limit Label	AI HIGH
25	2043	AI - Low Limit Label			Low Limit Label	AI LOW

In this menu you can get a full overview of all registers. Here you can directly edit in registers and see online values.

If you want to search for specific registers, you can use the filter function. The filter function can be applied to the register number, description and name.

If you want to see online or input values, select the tab with "online values" or "input registers".

If you want to filter, you can use the functions "start address" or "filter". If you use the start address, the desired address and the subsequent 100 registers are found. The filter function shows the specific search value. In case of changes, "reload data" is used to update the search function.

Address	Register	Value (s16)	Value (u32)	Value
1	200	201		65535
2	201	202	4294967295	65535
3	202	203		65535
4	203	204	4294967295	65535
5	204	205		65535
6	205	206	4294967295	65535
7	206	207	0	0
8	207	208	0	0
9	208	209		65535
10	209	210	4294967295	65535

Register list "quick-guide"

In- and output.

Analog input	Signal type	UINT32	INT32	INT32	INT32	INT32	INT32	INT32
		Status/Alarm	Actual value	Max. yesterday	High limit	High alarm limit	Low limit	Low alarm limit
AI 1	0/4-20mA	Høj grænse 8:0 Lav grænse 8:2	20	192	22	2011	24	2019

Digital input	Signal type	UINT32	UINT32	UINT32	UINT32	UINT32	UINT32	UINT32
		Status/Alarm	pulse total	pulses today	pulses yesterday	Operating time total (secs.)	Operating time today (secs.)	Operating time yesterday (secs.)
DI 1	"low" < 5V. "high" > 12V.	4:0	500	600	700	550	650	750
DI 2	"low" < 5V. "high" > 12V.	4:1	502	602	702	552	652	752
Description						(Seconds)	(Seconds)	(Seconds)

Digital output	Signal type	UINT32	UINT32	UINT32	UINT32	UINT32	UINT32	UINT32
		Status/Alarm	pulse total	pulses today	pulses yesterday	Operating time total (secs.)	Operating time today (secs.)	Operating time yesterday (secs.)
DO 1	Relay max 2A	2:3	804	904	1004	854	954	1054
DO 2	Relay max 2A	2:4	806	906	1006	856	956	1056
Description						(Seconds)	(Seconds)	(Seconds)

Pump	Signal type	UINT32	UINT32	UINT32	UINT32	UINT32	UINT32	UINT32
		Status/Command	Starts total	Starts today	Starts yesterday	Operating time total (secs.)	Operating time today (secs.)	Operating time yesterday (secs.)
Pump	Relay max 12A (Pump)	70	100	128	156	108	136	164
Description		<i>See section "pump word list"</i>				(Seconds)	(Seconds)	(Seconds)

Pump control.

Time and date	UINT32	System information	UINT32	System information	UINT16	System information	STR20/32
Seconds	80	Id number	0	TCP-port	2566	Name	2844
Minuttes	82	GSM-signal	94	GPRS-timeout	2564	Municipal	2854
Hours	84	IP-Address	2564			Geographical location	2870
Day	86					APN	2548
Month	88						
Year	90						

Levels	Function	UINT32
		Set-punkter
Starting level	Start	50
Stop level	Stop	54

Pumpe control	UINT32	UINT32	INT32	UINT32	UINT32	UINT32	UINT32	UINT32	UINT32
	Current	Min. current	Latest operating time	Latest capacity	Outlet flow	Inlet flow	Total quantity	Quantity today	Quantity yesterday
Pump	26	44	64	58	78	226	116	144	172
Description	<i>Current from energy meter, coil or CUE (Amps with 1 decimal)</i>	<i>Low current limit (Amps with 1 decimal) "If min. current is not exceeded, start failure occurs after 60 sec"</i>	<i>(Seconds)</i>	<i>Calculated capacity (L/s with 2 decimals)</i>	<i>Calculated flow (L/s with 2 decimals)</i>	<i>Calculated flow (L/s with 2 decimals)</i>	<i>Calculated quantity (m³ with 2 decimals)</i>	<i>Calculated quantity (m³ with 2 decimals)</i>	<i>Calculated quantity (m³ with 2 decimals)</i>

External gauges.

External gauges	UINT32	UINT32	UINT32
	Total	Today	Yesterday
Rain gauge	256	258	260
Description	<i>(0,2 mm per pulse with 1 decimal)</i>	<i>(0,2 mm per pulse with 1 decimal)</i>	<i>(0,2 mm per pulse with 1 decimal)</i>

Alarm and Warning.

Pumpword: Register 70	Status	Warning	Alarm
Bit 0: Pump started	√		
Bit 1: Pump error - Therma			√
Bit 2: Pump error - Klixon			√
Bit 3: Pump - manual mode			√
Bit 4: Pump error - operation signal not received			√
Bit 5: Internal			
Bit 5: Pump warning - Low flow		√	
Bit 6: Pump warning - long operation time (Time > total time / (total starts x 1,5))			
Bit 7: Internal			
Bit 8: Internal			√
Bit 9: Pump error - High level switch			√
Bit 10: Pump error - High level	√		
Bit 11: Pump - started by high level switch	√		
Bit 12: Pump - Back stopped			√
Bit 13: Pump error - repeatedly (needs to be reset)	√		
Bit 14: Pump - Manual mode	√		

Pumpword: Register 70	Status	Warning	Alarm
Bit 16: Pump - Manual mode by SCADA	√		
Bit 17: Pump - started manually by SCADA (Requires bit 16 = 1)	√		
Bit 18: Stop - manual mode	√		

PUMA status: Register 92	Status	Warning	Alarm
Bit 0: "Running blind" control active	√		
Bit 1: Internal	√		
Bit 2: Internal power supply failure			√
Bit 3: Internal			
Bit 4: Pump in error plus high level			√
Bit 5: Internal			
Bit 6: External power supply failure			√
Bit 7: Transmitter error			√
Bit 8: Pump in operation	√		
Bit 9: Internal			
Bit 10: Internal			
Bit 11: Control in alarm			√
Bit 12: Warning leakage		√	
Bit 13: Pump capacity needs update		√	
Bit 14: Internal			
Bit 15: Internal			
Bit 16: Internal			
Bit 17: Internal			
Bit 18: Internal			
Bit 19: Internal			
Bit 20: Back-stop control	√		
Bit 21: Internal			
Bit 22: Internal			
Bit 23: Internal			
Bit 24: Internal			
Bit 25: Waiting for depth pumping	√		
Bit 26: High level switch			√



Future safe Instrumentation

The mission of ACOWA Instruments is to deliver quality products for instrumentation, based on newest available technology and equipped with advanced, thoroughly tested functionality. Choosing an ACOWA products means choosing a future safe product.

High Speed development

If you choose ACOWA Instruments, you choose a future-proof product.

Our skilled developers constantly have a finger on the pulse and make sure that all products labelled ACOWA Instruments, are amongst the best on the market.

Danish design - from top to bottom,

ACOWA products are produced and developed in Denmark. This goes for hardware as well as software. On top of this, all development takes place in close dialogue with our customers.